

Magnetic relief valve VAN

OPERATING INSTRUCTIONS

· Edition 05.22 · EN · 03250824



CONTENTS

1 Safety	1
2 Checking the usage	2
3 Installation	2
4 Wiring	2
5 Tightness test.	4
6 Replacing the actuator.	4
7 Maintenance.	5
8 Accessories	5
9 Technical data	6
10 Designed lifetime	7
11 Certification	7
12 Logistics.	8
13 Disposal	8

1 SAFETY

1.1 Please read and keep in a safe place



Please read through these instructions carefully before installing or operating. Following the installation, pass the instructions on to the operator. This unit must be installed and commissioned in accordance with the regulations and standards in force. These instructions can also be found at www.docuthek.com.

1.2 Explanation of symbols

1, 2, 3, a, b, c = Action

→ = Instruction

1.3 Liability

We will not be held liable for damage resulting from non-observance of the instructions and non-compliant use.

1.4 Safety instructions

Information that is relevant for safety is indicated in the instructions as follows:

⚠ DANGER

Indicates potentially fatal situations.

⚠ WARNING

Indicates possible danger to life and limb.

⚠ CAUTION

Indicates possible material damage.

All interventions may only be carried out by qualified gas technicians. Electrical interventions may only be carried out by qualified electricians.

1.5 Conversion, spare parts

All technical changes are prohibited. Only use OEM spare parts.

2 CHECKING THE USAGE

Magnetic relief valve, open when de-energized, for the monitoring of gas valves for tightness used in conjunction with a visual discharge unit. For purging excess or leakage gas.

This function is only guaranteed when used within the specified limits – see page 6 (9 Technical data). Any other use is considered as non-compliant.

2.1 Type code

VAN	Magnetic relief valve
1-2	Sizes
10-50	Inlet and outlet flange nominal size
R	Rp internal thread
/N	Quick opening, quick closing
W	Mains voltage 230 V AC, 50/60 Hz
Q	Mains voltage 120 V AC, 50/60 Hz
K	Mains voltage 24 V DC
P	Mains voltage 100 V AC, 50/60 Hz
Y	Mains voltage 200 V AC, 50/60 Hz
S	Closed position switch with visual position indicator
G	Closed position switch for 24 V with visual position indicator
L	Viewing side: left
R	Viewing side: right

2.2 Part designations

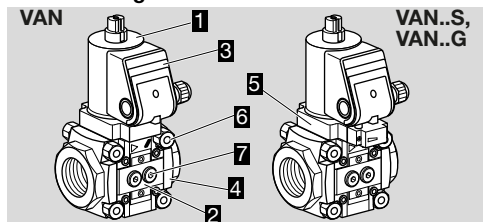

- 1 Solenoid actuator
- 2 Flow body
- 3 Connection box
- 4 Connection flange
- 5 Closed position indicator
- 6 Connection parts
- 7 Sealing plug

2.3 Type label

Mains voltage, electrical power consumption, ambient temperature, enclosure, inlet pressure and installation position: see type label.

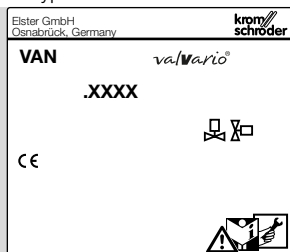

3 INSTALLATION

⚠ CAUTION

Incorrect installation

Please observe the following to ensure that the magnetic relief valve is not damaged during installation and operation:

- Sealing material and dirt, e.g. thread cuttings, must not be allowed to get into the valve housing.
- A filter must be installed upstream of every system.
- Dropping the device can cause permanent damage. In this event, replace the entire device and associated modules before use.
- Do not clamp the unit in a vice. Only secure the flange by holding the octagon with a suitable spanner. Risk of external leakage.
- Solenoid valves with closed position indicator VAN..S or VAN..G: actuator cannot be rotated.

- Install the unit in the pipe free of mechanical stress.
- Installation position: black solenoid actuator in the vertical upright position or tilted up to the horizontal, not upside down.

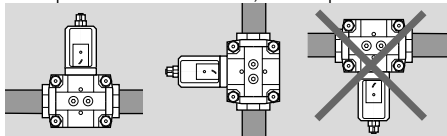

- The housing must not be in contact with masonry, minimum clearance 20 mm (0.79").

- 1 Obey the direction of flow as marked on the housing.



4 WIRING

⚠ WARNING

Risk of injury!

Please observe the following to ensure that no damage occurs:

- Electric shocks can be fatal! Before working on possible live components, ensure the unit is disconnected from the power supply.
- The solenoid actuator heats up during operation. Surface temperature approx. 85°C (approx. 185°F).



- Use temperature-resistant cable (> 80°C).

- 1 Disconnect the system from the electrical power supply.
 - 2 Shut off the gas supply.
- Wiring to EN 60204-1.
- Push through and remove the knock-out in the connection box before removing the cover. If the M20 cable gland or plug is already fitted, it is not necessary to remove the knock-out.

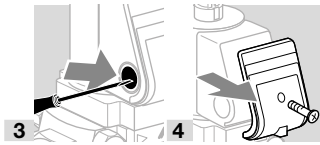

M20 cable gland

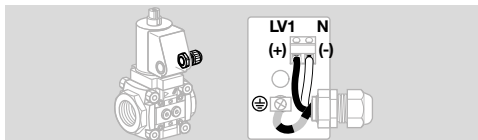
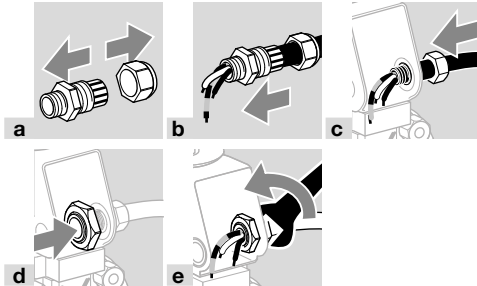

Plug

- LV1 (+) = black, N (-) = blue

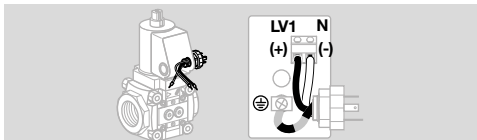
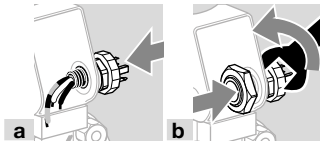

Socket

- 1 = N (-), 2 = LV1 (+)

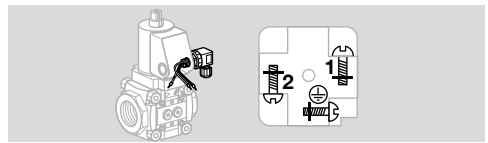
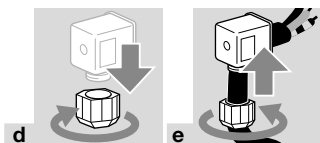
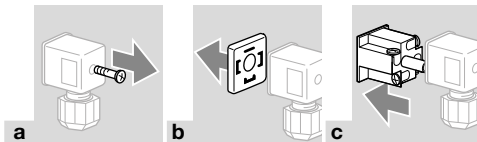

Closed position indicator

- VAN open: contacts 1 and 2 closed, VAN closed: contacts 1 and 3 closed.
- Indicator of closed position indicator: red = VAN closed, white = VAN open.

CAUTION

Please observe the following to ensure smooth operation:

- Route valve and closed position indicator cables separately through M20 cable glands or use two separate plugs. Otherwise, there is a risk of interference between valve voltage and closed position indicator voltage.
- To make wiring easier, the connection terminal for the closed position indicator can be removed.

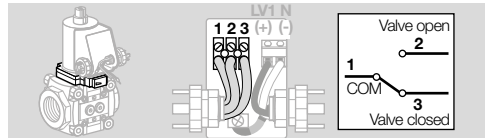
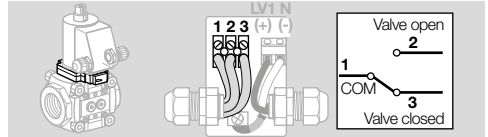

- When installing two plugs on a VAN with closed position indicator: label the sockets and plugs to avoid confusion.

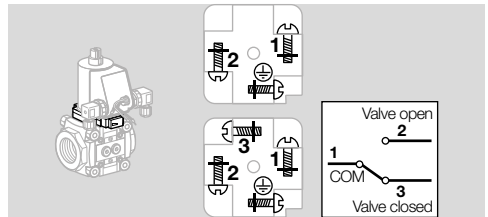

- Ensure that the connection terminal for the closed position indicator has been reconnected.

Finishing the wiring

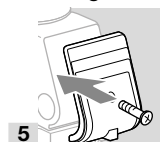

5 TIGHTNESS TEST

- 1 Close the gas solenoid valve.
- 2 To be able to check the tightness, shut off the downstream pipeline close to the valve.

$$N_2 \leq 1,5 \times p_{u \text{ max}}$$



- 3
- 4
- 5
- 6 Open the solenoid valve.

$$N_2 \leq 1,5 \times p_{u \text{ max}}$$



- 7
 - 8
 - 9 Tightness OK: open the pipeline.
- Pipeline leaking: replace the seal on the flange, see accessories. Then check for tightness once again.
 - Unit leaking: remove the unit and return it to the manufacturer.

6 REPLACING THE ACTUATOR

- The actuator adapter set for the new actuator must be ordered separately.

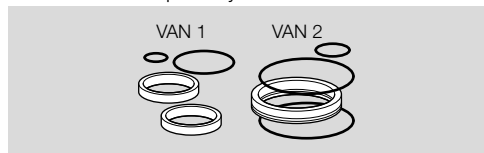

VAx 1, VCx 1: Order No. 74924468,
 VAx 2-3, VCx 2-3: Order No. 74924469.

- The seals of the actuator adapter set are covered with a non-stick coating. No additional grease is required.

- 1 Disconnect the system from the electrical power supply.
 - 2 Shut off the gas supply.
- Remove the M20 cable gland or other type of connection.

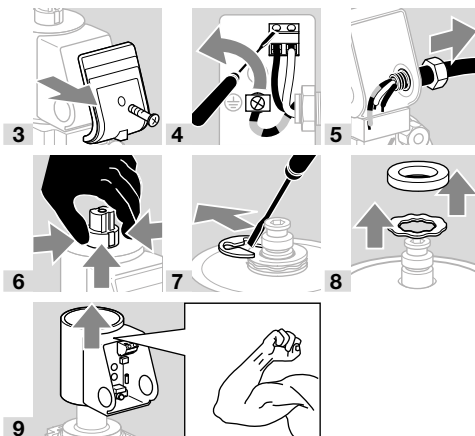

- Depending on the construction stage of the unit, there are two different methods for replacing the actuator: If the unit concerned has no O-ring in this place (arrow), replace the actuator as described here. Otherwise, go to the next note.



- a Insert seals.
- b Position of the metal ring can be selected.

VAx 1, VAN 1 VAx 2-3, VAN 2

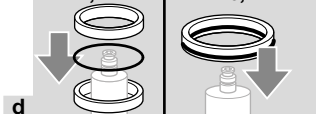

- d
- e Slide seal under the second groove.

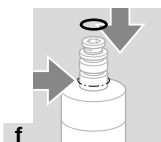

- If the unit concerned has an O-ring in this place (arrow), replace the actuator as described here: VAN 1: use all seals from the actuator adapter set. VAN 2: use the small seal from the actuator adapter set and only one of the large seals.

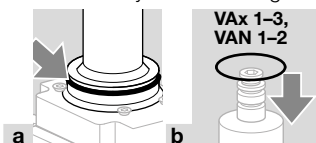

- a
- b
- c Slide seal under the second groove.

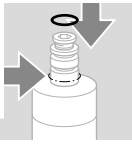

- d**
- 10** Position new actuator.
 - 11** Follow the reverse procedure when reassembling.
 - 12** Fit the M20 cable gland or plug and socket.
 - 13** Connect the VAN to the electrical power supply, see page 2 (4 Wiring).

7 MAINTENANCE

⚠ CAUTION

In order to ensure smooth operation, check the tightness and function of the unit:

- Once per year, twice per year in the case of biogas; check for internal and external tightness, see page 4 (5 Tightness test).
 - Check electrical installations once a year in line with local regulations; pay particular attention to the PE wire, see page 2 (4 Wiring).
- If the flow rate has dropped, clean the strainer.
- We recommend replacing the seals, see accessories, page 6 (8.2 Seal set VA 1–2).

- 1** Disconnect the system from the electrical power supply.
- 2** Shut off the gas supply.
- 3** Undo connection parts.

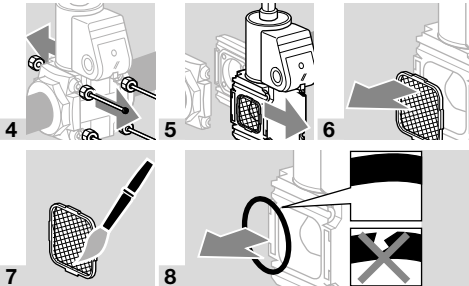

- 9** Once the seals have been replaced, follow the reverse procedure to reassemble the unit. Note the recommended tightening torques for the connection parts.

Connection parts	Tightening torque [Ncm]
VAx 1: M5	500 ± 50
VAx 2: M6	800 ± 50
VAx 3: M8	1400 ± 100

- 10** Then check the unit for internal and external tightness, see page 4 (5 Tightness test).

8 ACCESSORIES

8.1 Pressure switch for gas DG..VC

The pressure switch for gas monitors the inlet pressure p_u and the outlet pressure p_d .

- Monitoring the inlet pressure p_u : the pressure switch for gas is mounted on the inlet side.
- Monitoring the outlet pressure p_d : the pressure switch for gas is mounted on the outlet side.

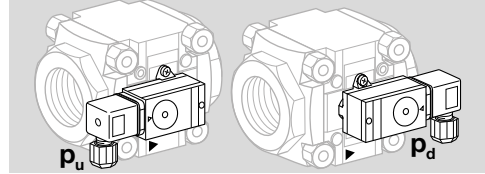

Scope of delivery:

- 1 x pressure switch for gas,
- 2 x self-tapping retaining screws,
- 2 x sealing rings.

Also available with gold-plated contacts for voltages of 5 to 250 V.

- When retrofitting the pressure switch for gas, see enclosed operating instructions “Pressure switches for gas DG..C”, section entitled “Mounting the DG..C.. on valVario gas solenoid valves”.

- The switching point is adjustable via hand wheel.

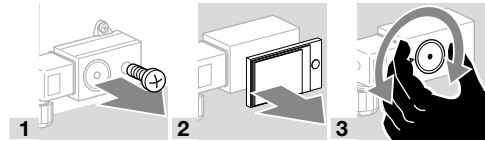

Type	Adjusting range (adjusting tolerance = ± 15% of the scale value)		Mean switching differential at min. and max. setting	
	[mbar]	[°WC]	[mbar]	[°WC]
DG 17VC	2–17	0.8–6.8	0.7–1.7	0.3–0.8
DG 40VC	5–40	2–16	1–2	0.4–1
DG 110VC	30–110	12–44	3–8	0.8–3.2
DG 300VC	100–300	40–120	6–15	2.4–8

- Deviation from the switching point during testing pursuant to EN 1854 Gas pressure switches: ± 15%.

8.2 Seal set VA 1–2

When retrofitting accessories or a second valVario control or when servicing, we recommend replacing the seals.

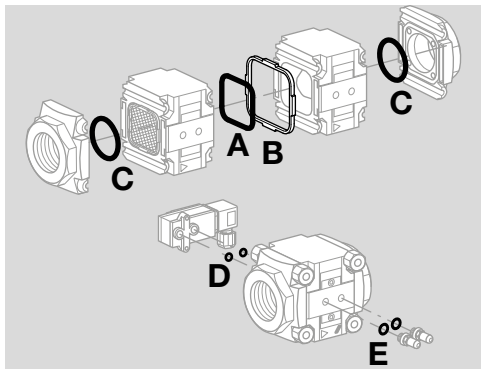

VA 1, Order No. 74921988,

VA 2, Order No. 74921989.

Scope of delivery:

- A** 1 x double block seal,
- B** 1 x retaining frame,
- C** 2 x O-rings (flange),
- D** 2 x O-rings (pressure switch),

for test nipple/screw plug:

- E** 2 x sealing rings (flat sealing),
- 2 x profiled sealing rings.

9 TECHNICAL DATA

9.1 Ambient conditions

Icing, condensation and dew in and on the unit are not permitted.

Avoid direct sunlight or radiation from red-hot surfaces on the unit. Note the maximum medium and ambient temperatures!

Avoid corrosive influences, e.g. salty ambient air or SO₂. The unit may only be stored/installed in enclosed rooms/buildings.

The unit is suitable for a maximum installation height of 2000 m AMSL.

Ambient temperature: -20 to +50°C (-4 to +122°F), no condensation permitted.

Long-term use in the upper ambient temperature range accelerates the ageing of the elastomer materials and reduces the service life (please contact manufacturer).

Storage temperature = transport temperature: -20 to +40°C (-4 to +104°F).

Enclosure: IP 65.

This unit is not suitable for cleaning with a high-pressure cleaner and/or cleaning products.

9.2 Mechanical data

Gas types: natural gas, LPG (gaseous), biogas (max. 0.1 % by-vol. H₂S) or clean air; other types of gas on request. The gas must be clean and dry in all temperature conditions and must not contain condensate.

Medium temperature = ambient temperature.

Max. inlet pressure p₁: 500 mbar (7.25 psig).

Leakage rate: ≤ 500 cm³/h (0.132 gal/h).

Closing time: quick closing: < 1 s.

Switching frequency: max. 15 x per minute.

Cable gland: M20 x 1.5.

Electrical connection: cable with max. 2.5 mm² (AWG 12) or plug with socket to EN 175301-803.

Duty cycle: 100%.

Power factor of the solenoid coil: cos φ = 0.9.

Safety valve:

Class A, Group 2 pursuant to EN 13611 and EN 161.

Valve housing: aluminium, valve seal: NBR.

Connection flanges with internal thread:

Rp to ISO 7-1, NPT to ANSI/ASME.

9.3 Electrical data

Mains voltage:

230 V AC, +10/-15%, 50/60 Hz,

200 V AC, +10/-15%, 50/60 Hz,

120 V AC, +10/-15%, 50/60 Hz,

100 V AC, +10/-15%, 50/60 Hz,

24 V DC, ±20%.

Power consumption:

Type	Voltage	Power
VAN 1	24 V DC	25 W
VAN 1	100 V AC	25 W (26 VA)
VAN 1	120 V AC	25 W (26 VA)
VAN 1	200 V AC	25 W (26 VA)
VAN 1	230 V AC	25 W (26 VA)
VAN 2	24 V DC	36 W
VAN 2	100 V AC	36 W (40 VA)
VAN 2	120 V AC	40 W (44 VA)
VAN 2	200 V AC	40 W (44 VA)
VAN 2	230 V AC	40 W (44 VA)

Contact rating of closed position indicator:

Type	Voltage	Current (resistive load)	
		min.	max.
VAN..S	12–250 V AC, 50/60 Hz	100 mA	3 A
VAN..G	12–30 V DC	2 mA	0.1 A

Switching frequency of closed position indicator: max. 5 x per minute.

Switching current	Switching cycles*	
	cos φ = 1	cos φ = 0.6
0.1	500,000	500,000
0.5	300,000	250,000
1	200,000	100,000
3	100,000	–

* Limited to max. 200,000 cycles for heating systems.

9.4 Air flow rate Q

Air flow rate Q for a pressure loss of $\Delta p = 1$ mbar (0.4 "WC):

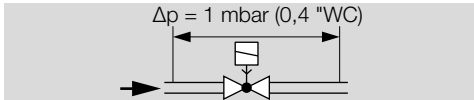

	Air flow rate	
	Q [m³/h]	Q [SCFH]
VAN 110	4.4	155.4
VAN 115	5.6	197.7
VAN 120	8.3	293.1
VAN 125	10	353.1
VAN 225	15.5	547.3
VAN 232	19.5	688.5
VAN 240	21	741.5
VAN 250	22.5	794.5

10 DESIGNED LIFETIME

This information on the designed lifetime is based on using the product in accordance with these operating instructions. Once the designed lifetime has been reached, safety-relevant products must be replaced. Designed lifetime (based on date of manufacture) in accordance with EN 13611, EN 161 for VAN:

Type	Designed lifetime	
	Switching cycles	Time (years)
VAN 110 – 225	500,000	10
VAN 232 – 250	200,000	10

You can find further explanations in the applicable rules and regulations and on the afecor website (www.afecor.org).

This procedure applies to heating systems. For thermostating equipment, observe local regulations.

11 CERTIFICATION

11.1 Declaration of conformity



We, the manufacturer, hereby declare that the products VAN with product ID No. CE-0063BU1564 comply with the requirements of the listed Directives and Standards.

Directives:

- 2014/35/EU – LVD
- 2014/30/EU – EMC
- 2011/65/EU – RoHS II
- 2015/863/EU – RoHS III

Regulation:

- (EU) 2016/426 – GAR

Standards:

- EN 161:2011+A3:2013

The relevant product corresponds to the tested type sample.

The production is subject to the surveillance procedure pursuant to Regulation (EU) 2016/426 Annex III paragraph 3.

Elster GmbH

Scan of the Declaration of conformity (D, GB) – see www.docuthek.com

AGA approved



Australian Gas Association

Eurasian Customs Union



The product VAN meets the technical specifications of the Eurasian Customs Union.

11.2 UKCA certified



Gas Appliances (Product Safety and Metrology etc. (Amendment etc.) (EU Exit) Regulations 2019)
BS EN 161:2011+A3:2013

11.3 REACH Regulation

The device contains substances of very high concern which are listed in the Candidate List of the European REACH Regulation No. 1907/2006. See Reach list HTS at www.docuthek.com.

11.4 China RoHS

Directive on the restriction of the use of hazardous substances (RoHS) in China. Scan of the Disclosure Table China RoHS2, see certificates at www.docuthek.com.

12 LOGISTICS

Transport

Protect the unit from external forces (blows, shocks, vibration).

Transport temperature: see page 6 (9.1 Ambient conditions).

Transport is subject to the ambient conditions described.

Report any transport damage on the unit or packaging without delay.

Check that the delivery is complete.

Storage

Storage temperature: see page 6 (9.1 Ambient conditions).

Storage is subject to the ambient conditions described.

Storage time: 6 months in the original packaging before using for the first time. If stored for longer than this, the overall service life will be reduced by the corresponding amount of extra storage time.

13 DISPOSAL

Devices with electronic components:

WEEE Directive 2012/19/EU – Waste Electrical and Electronic Equipment Directive



At the end of the product life (number of operating cycles reached), dispose of the packaging and product in a corresponding recycling centre. Do not dispose of the unit with the usual domestic refuse. Do not burn the product. On request, old units may be returned carriage paid to the manufacturer in accordance with the relevant waste legislation requirements.

FOR MORE INFORMATION

The Honeywell Thermal Solutions family of products includes Honeywell Combustion Safety, Eclipse, Exothermics, Hauck, Kromschroder and Maxon. To learn more about our products, visit ThermalSolutions.honeywell.com or contact your Honeywell Sales Engineer.

Elster GmbH
Strotheweg 1, D-49504 Lotte
T +49 541 1214-0
hts.lotte@honeywell.com
www.kromschroeder.com

Global centralized service deployment coordination:
T +49 541 1214-365 or -555
hts.service.germany@honeywell.com

Translation from the German
© 2022 Elster GmbH

Honeywell
kromschroder